

9001621982 (060420)



mm

- de** Montageanleitung
- en** Installation instructions
- fr** Notice d'installation
- it** Istruzioni d'installazione
- nl** Installatie-instructies
- es** Instrucciones de montaje
- pt** Instruções de instalação
- el** Οδηγίες εγκατάστασης
- da** Installationsvejledning
- no** Installasjonsveiledning
- sv** Installationsanvisningar

- fi** Asennusohjeet
- et** Paigaldusjuhised
- lt** Įrengimo instrukcijos
- lv** Uzstādīšanas instrukcijas
- pl** Instrukcje montażu
- hu** Telepítési útmutató
- cs** Pokyny k instalaci
- sl** Navodila za montažo
- uk** Інструкція з монтажу
- kk** Орнату нұсқаулықтар
- ru** Инструкция по установке

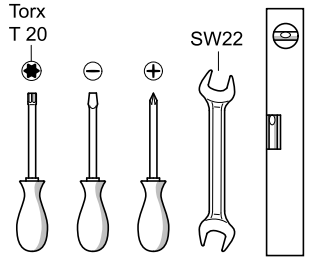
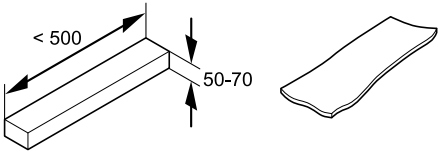
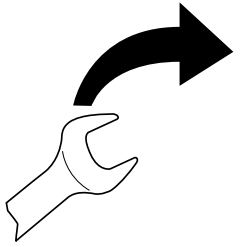
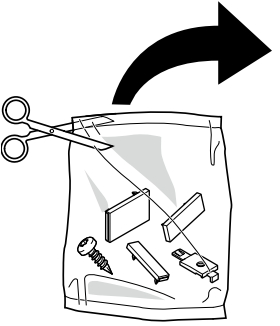

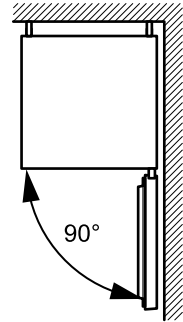
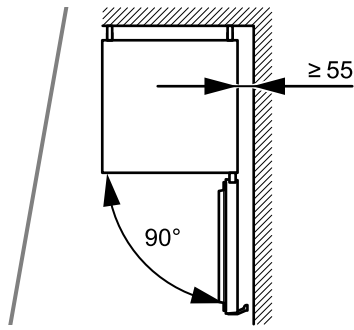
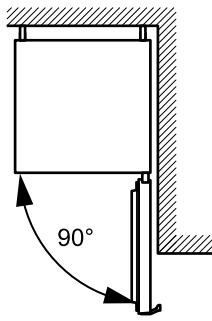
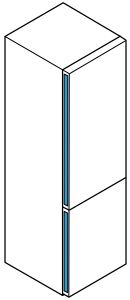
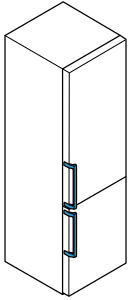
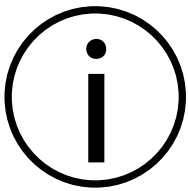

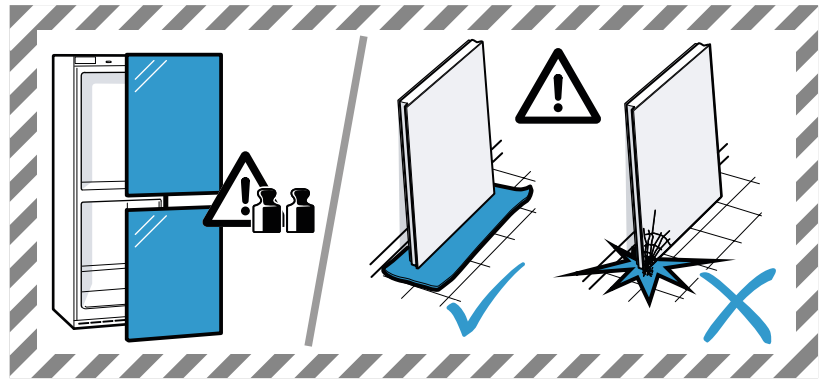
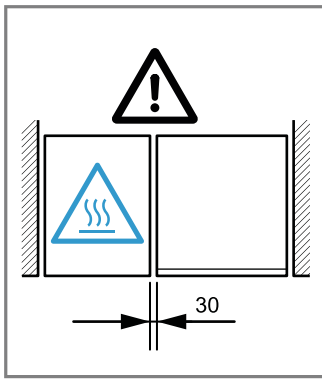
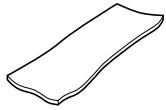
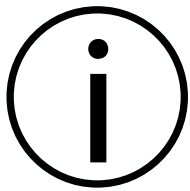

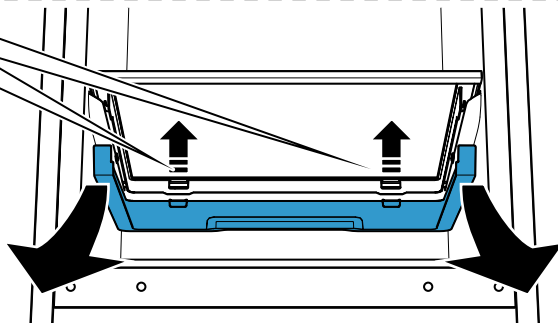
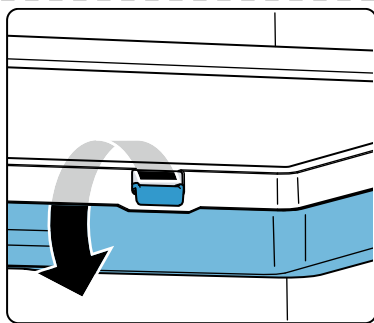
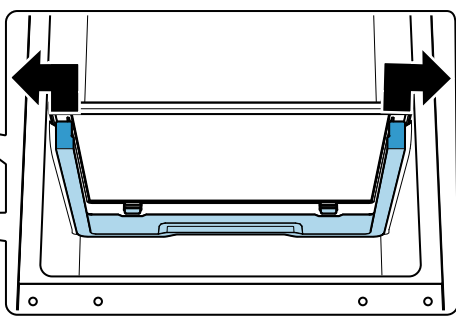
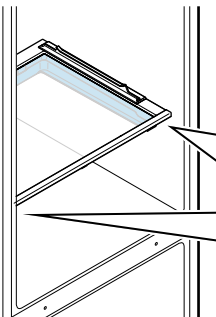
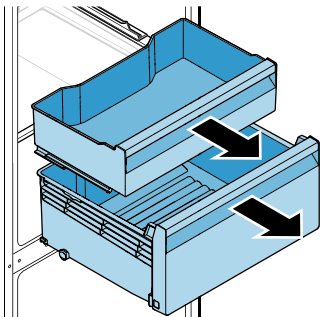
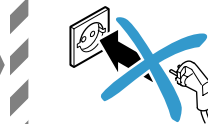
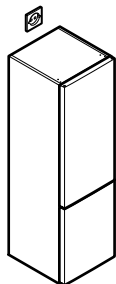
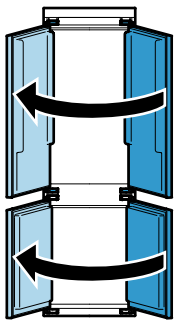
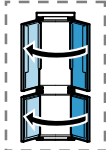

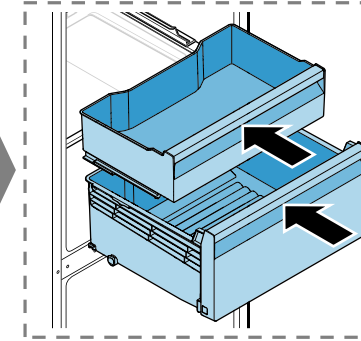
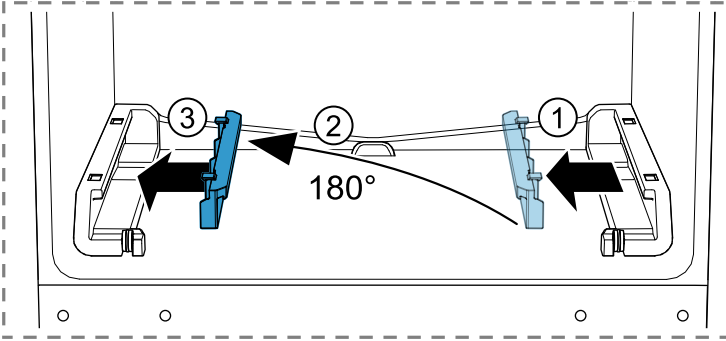
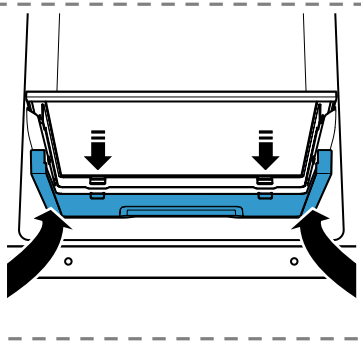
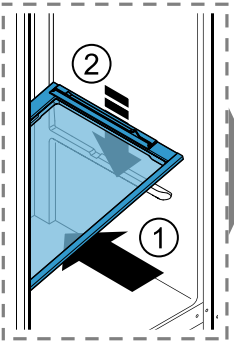
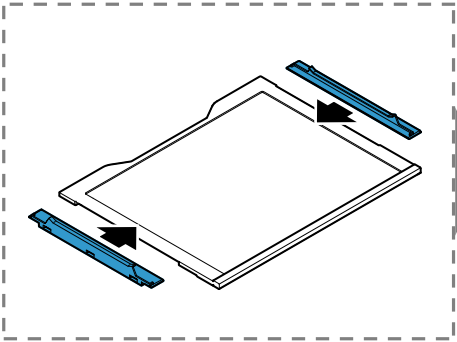
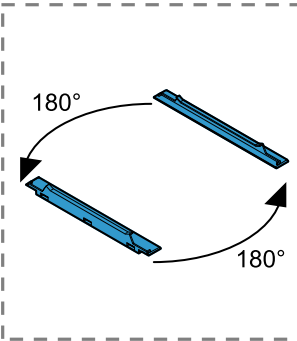
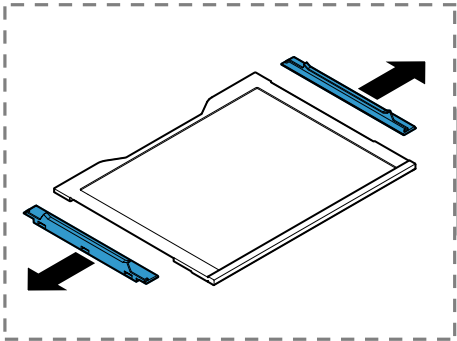
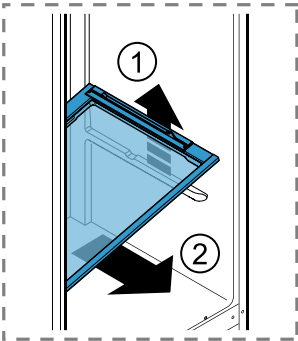
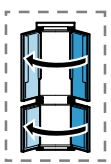

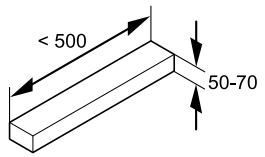
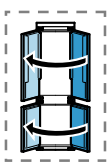

Torx
T 20

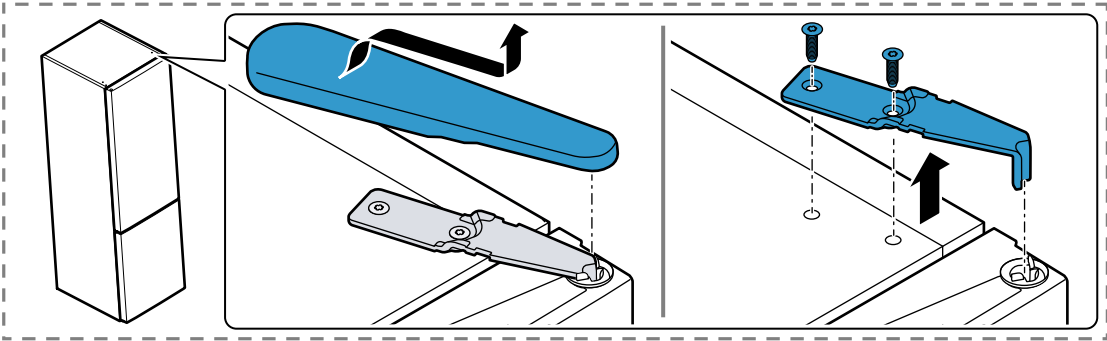
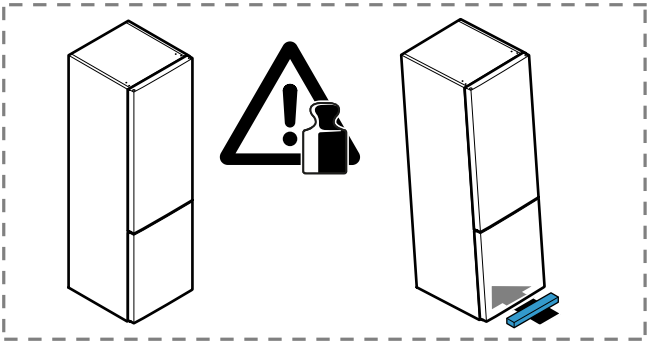

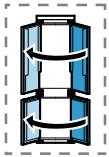

Torx
T 20

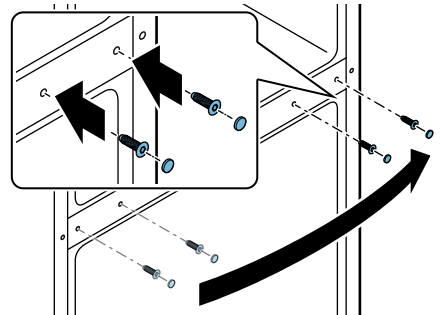
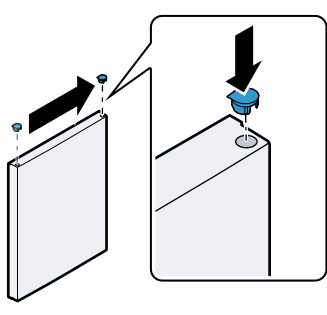
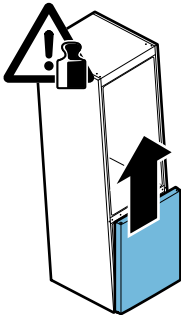
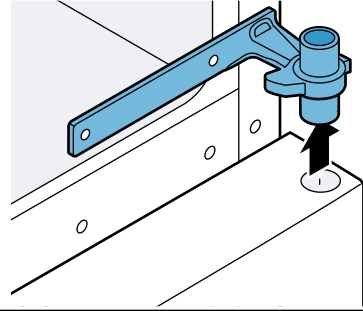
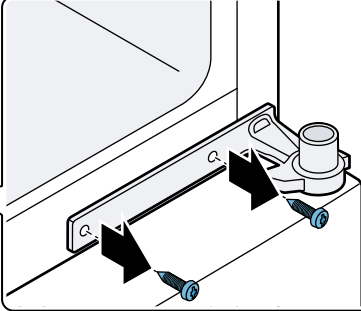
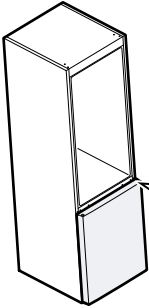
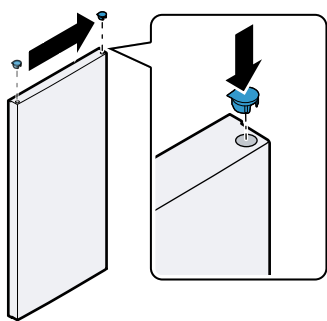
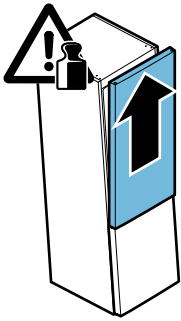
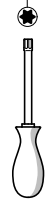

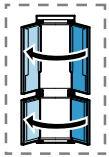

Torx
T 20

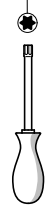

SW22

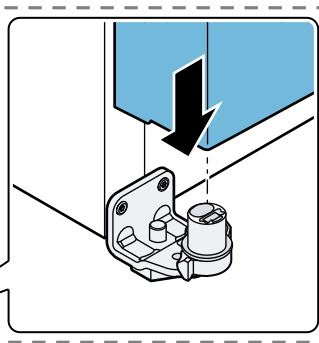
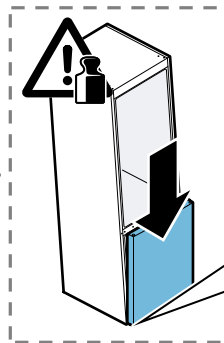
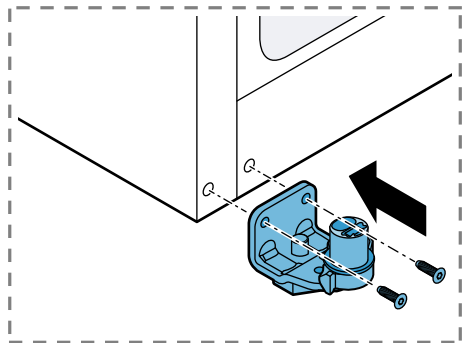
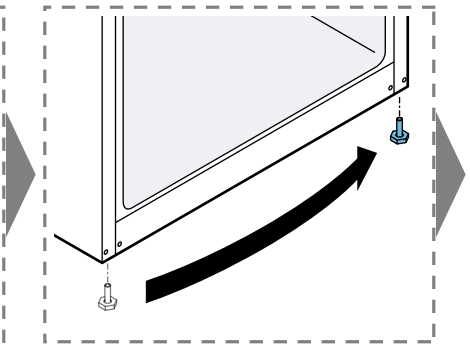
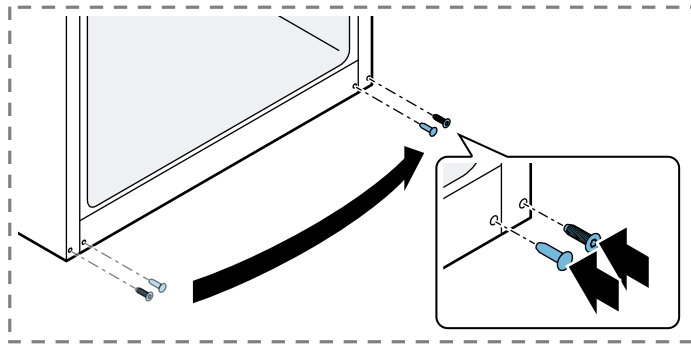
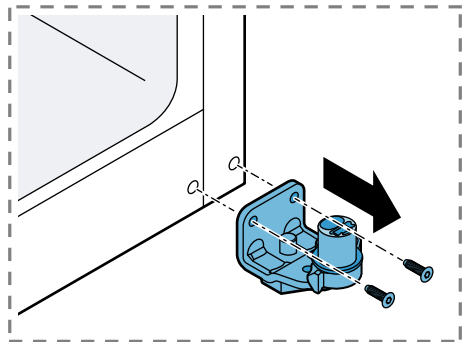
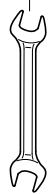

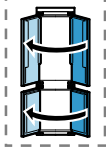

Torx
T 20

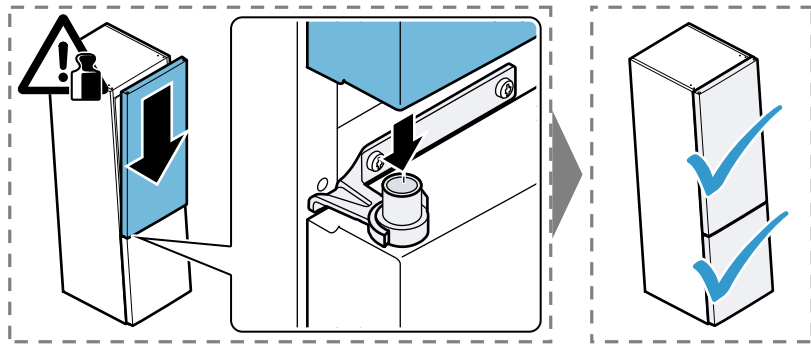
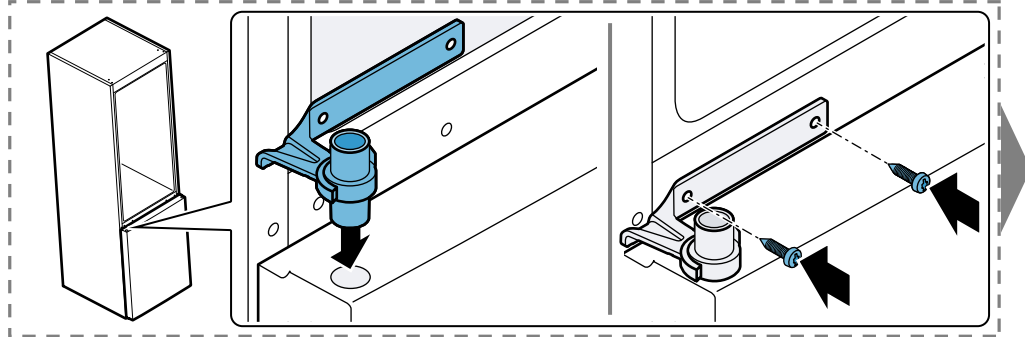
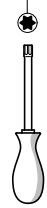

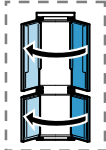

Torx
T 20

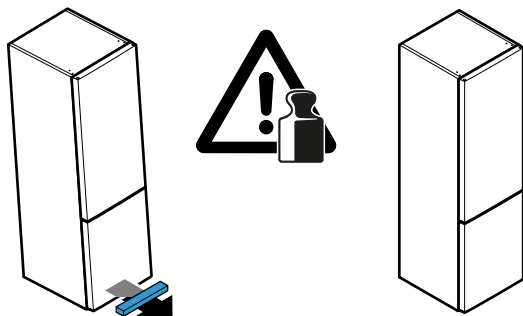
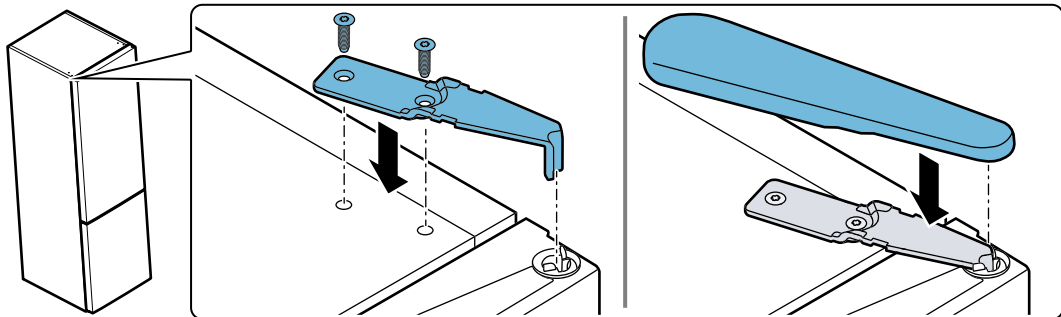
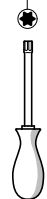

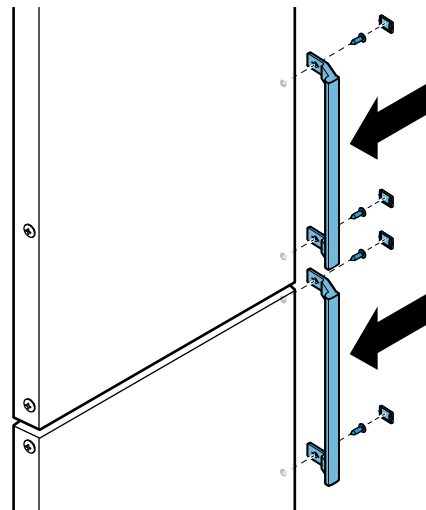
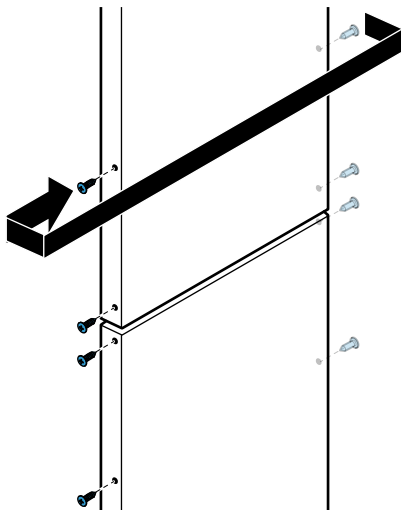
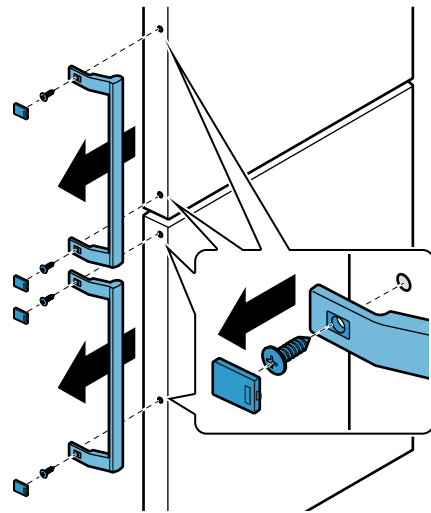
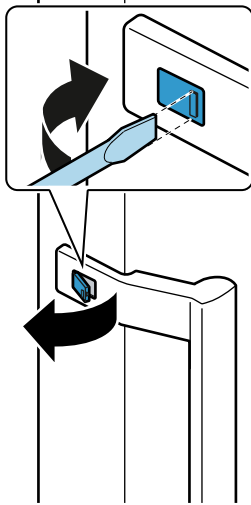
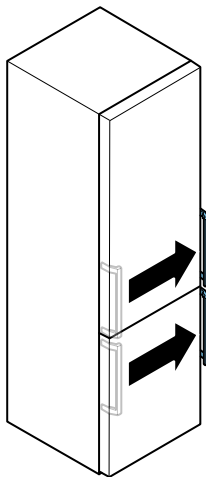
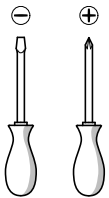
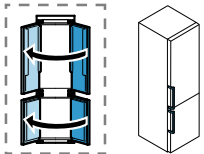

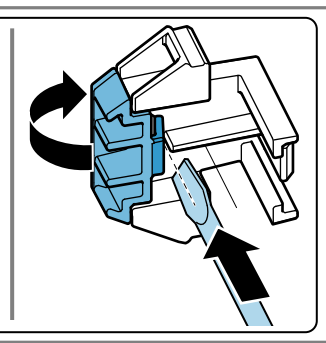
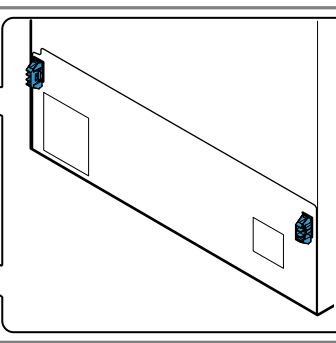
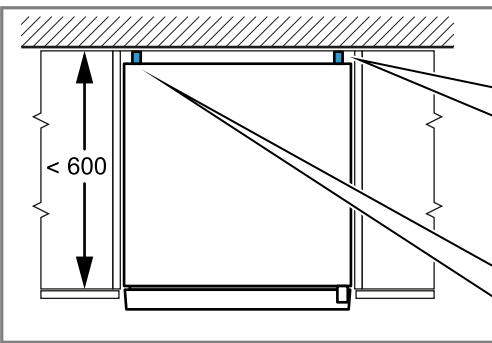
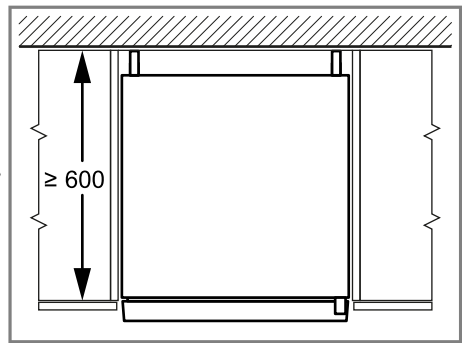
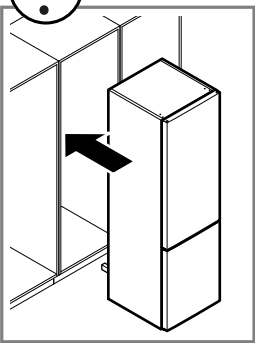
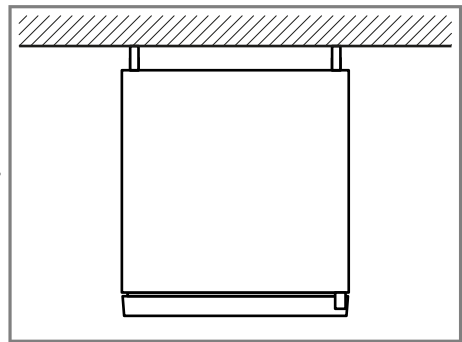
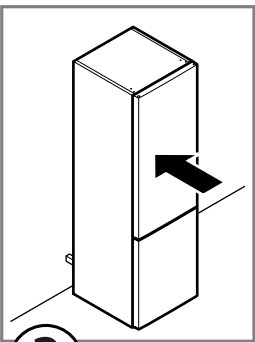
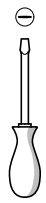



SW22

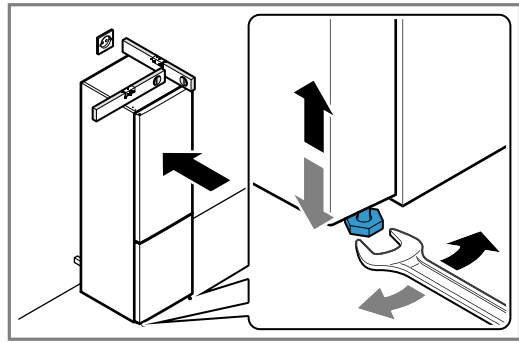
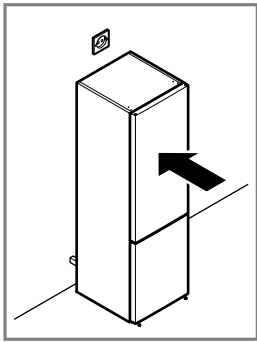
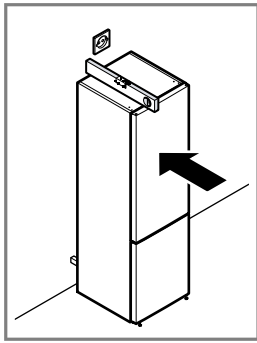
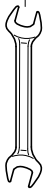



A series of horizontal lines for writing, starting from a vertical margin line on the left and extending across the page.

